

■ FEATURE:

- Fast Response Time.
- High Analytic.
- Cut-Off Visible Wavelength $\lambda_p=940\text{nm}$
- High sensitivity.
- Lead Free product, in compliance with RoHS.

■ DESCRIPTIONS:

- GT250-FA consist of an infrared emitting diode and a phototransistor, encased side-by-side on converging optical axis in a black thermoplastic housing the phototransistor receives radiation from the IR LED only. This is the normal situation. But when an object is in between, the phototransistor could not receive the radiation.

■ APPLICATIONS:

- Mouse copier.
- Switch scanner.
- Floppy disk driver.
- Non contact switching.

■ INTERNAL CIRCUIT:

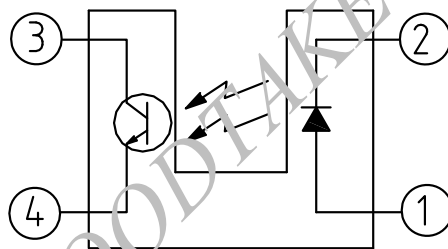

■ DIMENSIONS

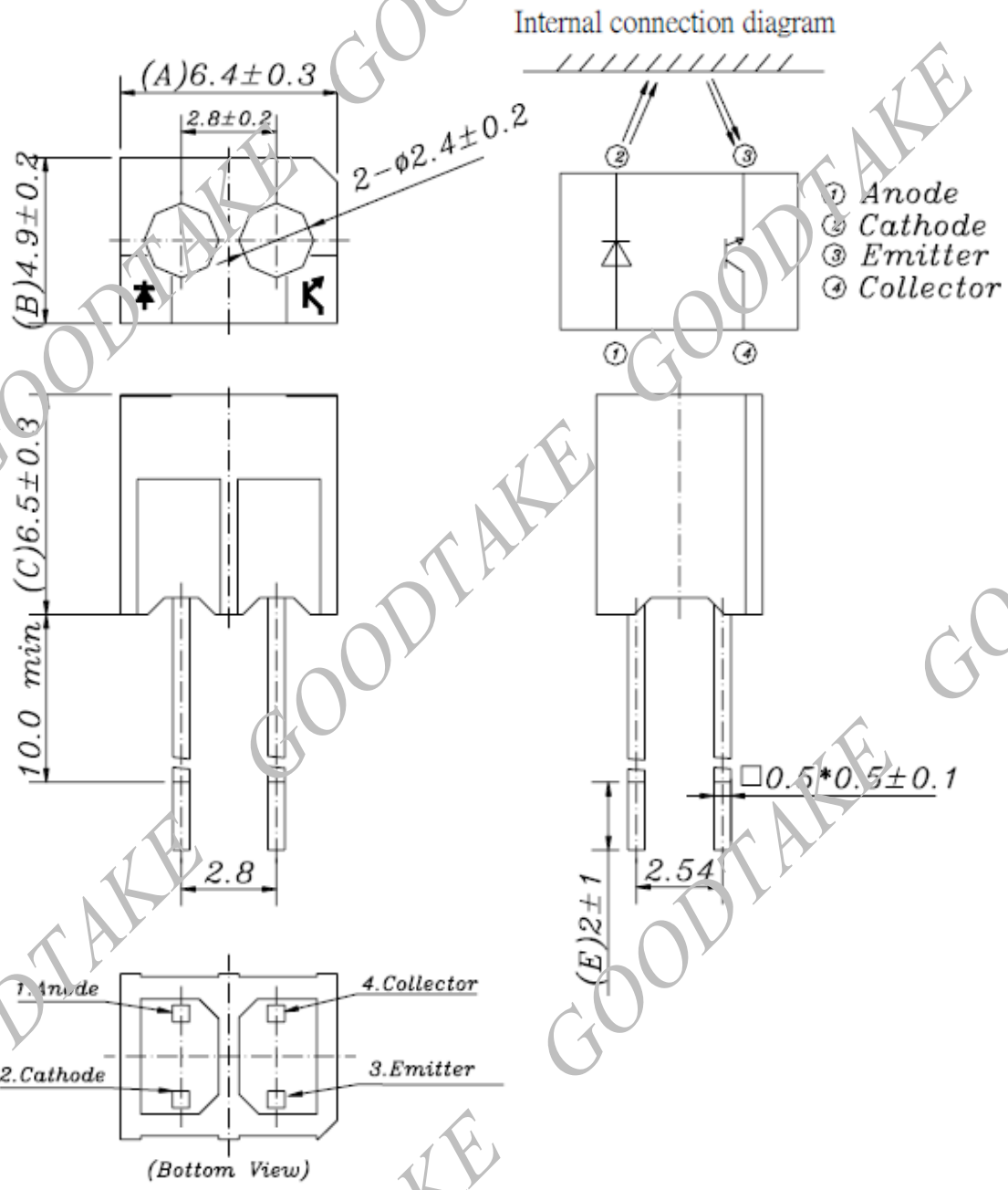

NOTE: 1. All dimensions are in millimeter.
 2. Tolerance is ± 0.2 unless otherwise noted.

■ ABSOLUTE MAXIMUM RATINGS AT $T_a=25^{\circ}\text{C}$

Parameter		Symbol	Ratings	Unit
Input	Power Dissipation	P_D	75	mW
	Reverse Voltage	V_R	5	V
	Forward Current	I_F	50	mA
	Peak Forward Current	I_{FP}	1	A
Output	Collector Power Dissipation	P_c	75	mW
	Collector Current	I_c	20	mA
	Collector-Emitter Breakdown Voltage	BV_{CEO}	30	V
	Emitter-Collector Breakdown Voltage	BV_{ECO}	5	V
Operating Temperature		T_{opr}	-25~+85	$^{\circ}\text{C}$
Storage Temperature		T_{stg}	-40~+85	$^{\circ}\text{C}$
Soldering Temperature		T_{sol}	270 $^{\circ}\text{C}$ for 6 sec Max (2mm from Body)	

NOTES: I_{FP} CONDITIONS--PULSE WIDTH $\leq 100\mu\text{s}$ AND DUTY $\leq 1\%$.

■ TYPICAL ELECTRICAL & OPTICAL CHARACTERISTICS ($T_a=25^{\circ}\text{C}$)

Parameter		Symbol	Min.	Type	Max.	Unit	Test Condition
Input	Forward Voltage	V_F		1.25	1.5	V	$I_F=50\text{ mA}$
	Reverse Current	I_R			10	μA	$V_F=5\text{V}$
	Peak Wavelength	λ_P		940		nm	
	View Angle	$2\theta_{1/2}$		60		Deg	
Output	Collector Dark Current	I_{CEO}			100	nA	$V_{CE}=10\text{V}$
	Collector-Emitter Saturation Voltage	$V_{CE(sat)}$			0.4	V	$I_c=2\text{mA}$ $I_B=100\mu\text{A}$
Transfer Characteristics	On State Collector Current	$I_{C(on)}$	0.2	-	-	mA	$V_{CE}=5\text{V}$ $I_F=20\text{mA}$
	Rise Time	T_r		15		μs	$V_{CE}=5\text{V}$ $I_c=1\text{mA}$
	Fall Time	T_f		15		μs	$R_L=1000\Omega$

■ RELIABILITY TEST ITEMS AND CONDITIONS:

NO	Item	Test Conditions	Test Hours/Cycle	Sample Quantity	Test Result
1	Solder Heat	TEMP: 270°C ± 3°C	10 SEC	11 pcs	0 DEFECT
2	Temperature Cycle	H: +85°C 180min ↓ 10min L: -25°C 180min	16 cycles	22 pcs	0 DEFECT
3	Thermal Shock	H: +85°C 30min ↓ 30sec L: -25°C 30min	10 cycles	11 pcs	0 DEFECT
4	High Temperature Storage	TEMP: +25°C	1000 HRS	22 pcs	0 DEFECT
5	Low Temperature Storage	TEMP: -25°C	1000 HRS	22 pcs	0 DEFECT
6	High Temperature High Humidity Storage	85°C / 33% RH	1000HRS	22 pcs	0 DEFECT

■ TYPICAL ELECTRO-OPTICAL CHARACTERISTICS CURVES FOR IR:

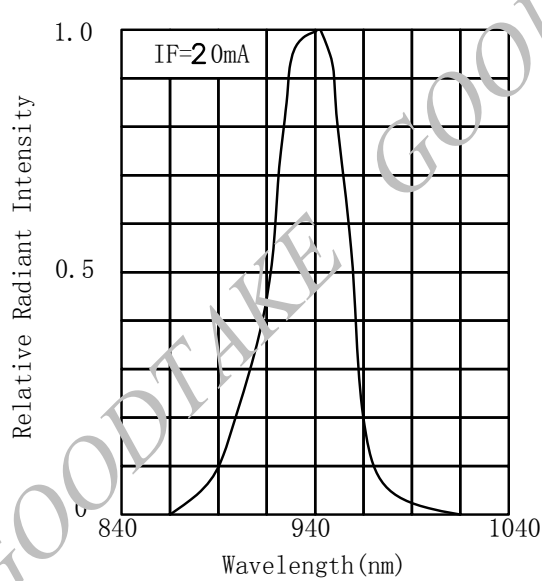

Fig. 1 Spectral Distribution

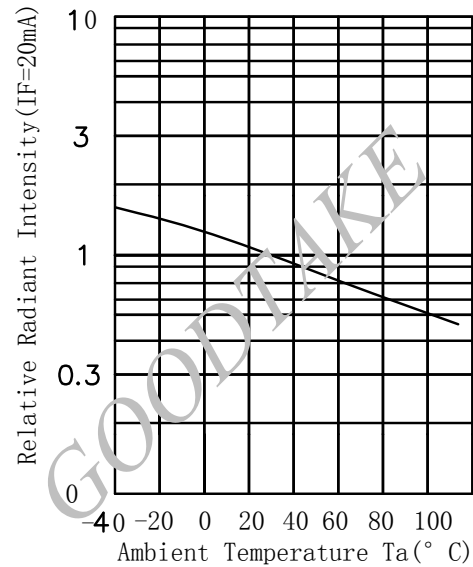

Fig. 2 Relative Radiant Intensity Vs Ambient Temperature

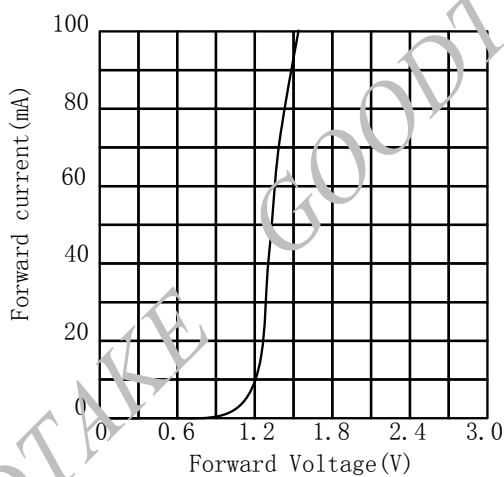

Fig. 3 Forward Current Vs Forward Voltage

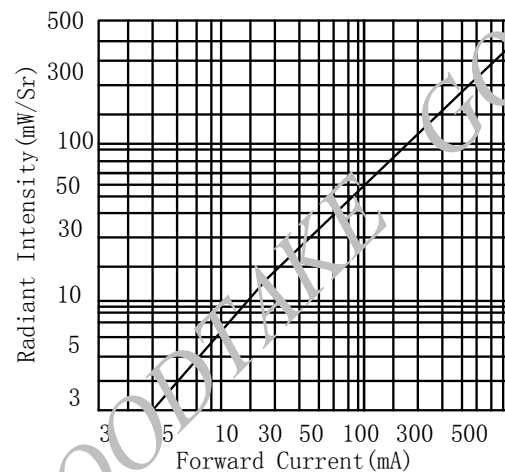

Fig. 4 Forward Current Vs Radiant Intensity

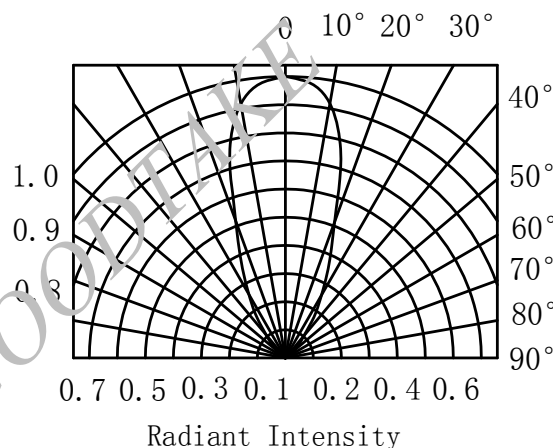

Fig. 5 Angle Vs Radiant Intensity

■ TYPICAL ELECTRO-OPTICAL CHARACTERISTICS CURVES FOR PT

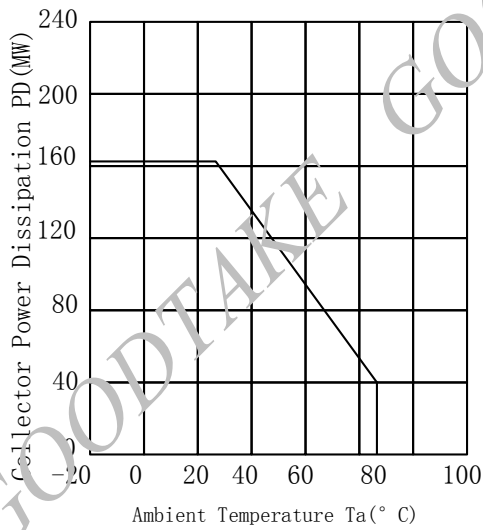

FIG. 1 Collector Pd vs Ta

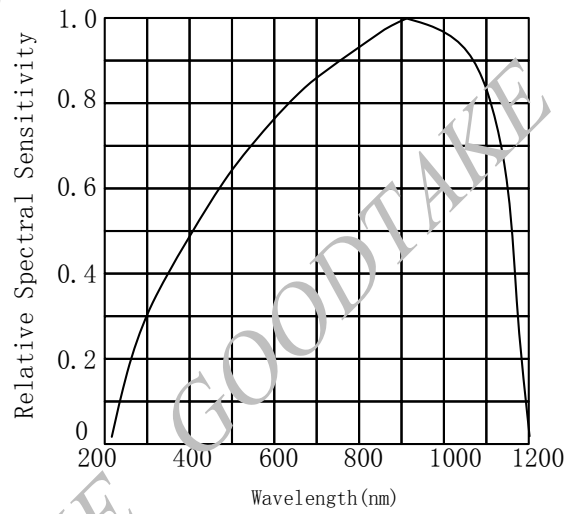

FIG. 2 Spectral Sensitivity

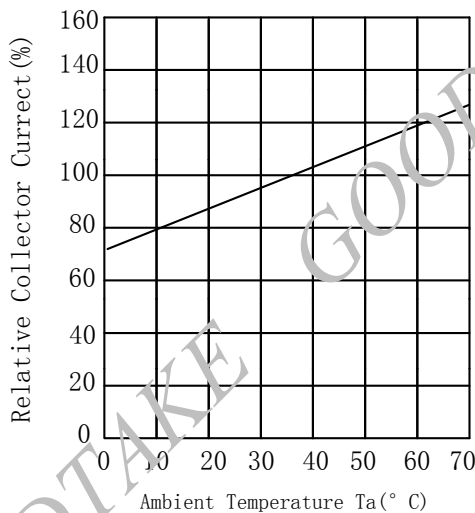

FIG. 3 Relative Ic vs. Ta

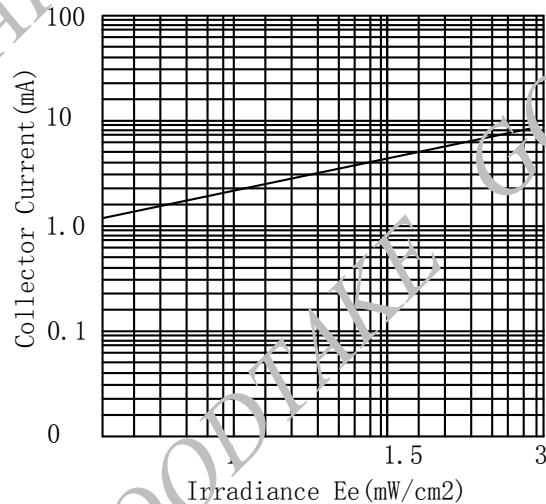

FIG. 4 Ic vs Iv

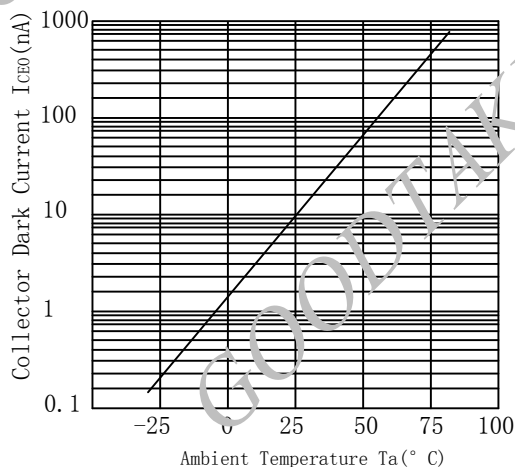

FIG. 5 Id vs Ta

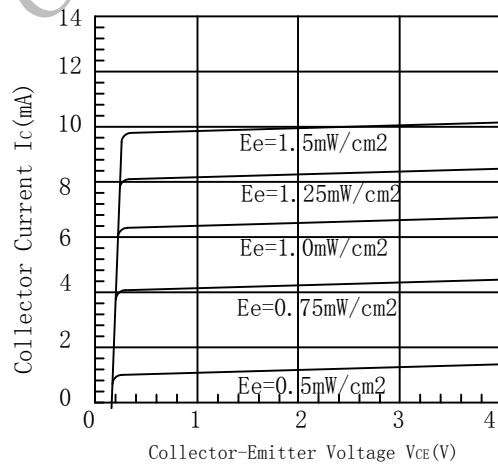

FIG. 6 Collector Current VS Collector-Emitter Voltage